



GEEPLUS

Open Frame Solenoid SK-A0730

Device drawn in energised condition
 Life Expectancy >250K cycles
 Leadwires UL1007, 26AWG, 240mm

Plunger Mass 8 grammes
 Total Mass 48 grammes

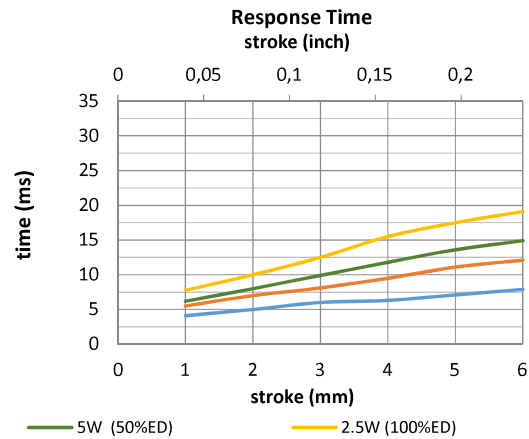
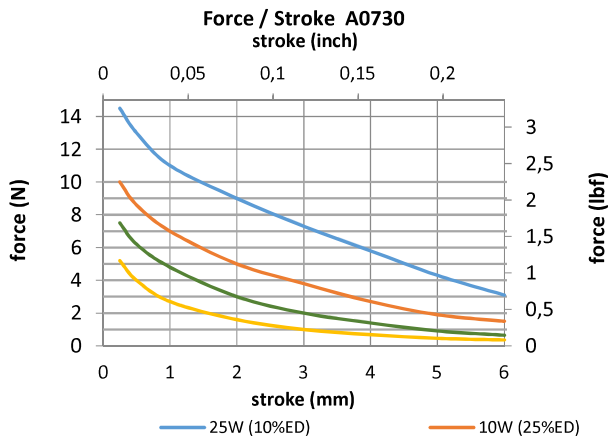
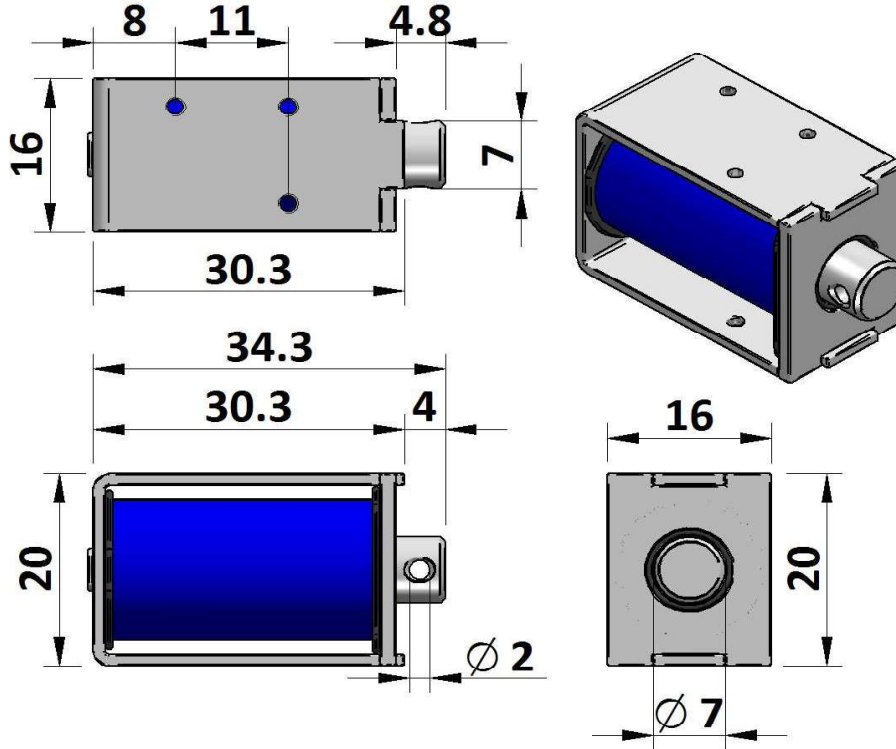

Data at 20°C, device performance measured without heat sink

duty cycle = $\frac{\text{"on" time}}{\text{"on" time} + \text{"off" time}} \times 100\%$			100% cont.	50% or less	25% or less	10% or less
Max. "on" time in seconds			∞	100	36	7
watts at 20°C			2,5	5,0	10,0	25,0
ampere-turns at 20°			389	550	778	1230
AWG no.	resistance	number of turns	volts DC			
	$\Omega \pm 10\%$ (at 20°C)					
SK-A0730-6v	14	990	6,0	8,5	12,0	19,0
SK-A0730-12v	58	1925	12,0	17,0	24,0	38,0
SK-A0730-24v	230	3730	24,0	34,0	48,0	76,0
SK-A0730-48v	922	7300	48,0	68,0	96,0	152

Insulation Resistance >100MΩ, 500VDC Megger

Dielectric Strength 500VAC, 50/60Hz, 1 minute

Class A (105°C) insulation class

Geeplus reserves the right to change specifications without notice

www.geeplus.com