

# Brushless DC Motors with Integral Speed Drive

## KinetiMax 68 EB Series

*68 mm diameter, up to 170 mNm cont. torque, up to 50 W output power*

The KinetiMax 68 EB series of brushless DC motors with integrated drive electronics are compact yet powerful outer-rotor motors. The external rotor and iron core stator minimize cogging and maximize output torque. The KinetiMax 68 motors are designed with a bearing system capable of handling high side loads.

High quality components ensure the KinetiMax 68 motor life exceeds 20,000 hours. The output torque range of this family has a maximum of 170 mNm, and the speed range extends to 6000 RPM.

Typical applications for the KinetiMax 68 include many types of gear pumps and peristaltic pumps, high-end fans and blowers, and laboratory equipment.

### Options & Accessories

- Special shaft diameter and machining
- Customized mounting flange
- Custom leads and connector configurations
- Special winding configurations
- Provisions for gearbox mounting
- IP 55 rating
- PWM or frequency speed set in place of analog input



### Features & Benefits

- Outer-rotor precision 68 mm dia. brushless DC motor with integrated drive electronics
- Models rated at 35 and 50 W output power, rated torque up to 170 mNm, no-load speed up to 6000 RPM
- Adjustable speed and direction selection
- Thermal overload protection with automatic recovery
- Low EMI – complies with EN 55014-1/2, EN 61000-6-1/3
- Standard IP43 protection level
- Model 01658033 includes integral electrical brake





### QuickShip Products

Some of the part number configurations for this product are in stock and available for ***immediate delivery!***

Look for the QuickShip symbol next to available part numbers. Then, click on the part number to go directly to our online store.



## KinetiMax 68 EB – Specifications

		KMX-01658041	KMX-01658033	 <a href="#">KMX-01658013</a>	 <a href="#">KMX-01658023</a>
Model		KMX-01658041	KMX-01658033	 <a href="#">KMX-01658013</a>	 <a href="#">KMX-01658023</a>
Length		49.1 (1.93)	62.1 (2.44)		
Voltage VDC	Nominal	24			
	Range <sup>1</sup>	14 – 30			
Rated Output Power	W	35		50	
Torque mNm (oz.in.)	Rated	70 (9.9)	110 (15.6)		170 (24.0)
	Max	90 (12.7)	150 (21.2)	120 (17.0)	180 (25.5)
Speed RPM	Rated	3650	2500	3750	2400
	No-load	6000	4330	6000	3650
Current A	Rated – A	2		3	
	Max – A	2.3	3.4		
	No-load – mA	215	180	260	265
Rotor Inertia kgm <sup>2</sup> (oz.in.s <sup>2</sup> )		0.75 E-4 (0.0106)	1.2 E-4 (0.017)		
Mechanical Time Constant ms		30	40		25
Thermal Resistance Housing-Ambient °C/W		4.2	3.7		
Weight g (oz)		450 (15.9)	550 (19.4)		
Protection Level		IP43			
Gearbox (option)		On request			
Speed-Voltage Input Ratio	RPM/V	1000	1100	1000	
Speed Input V	Set Point	0 - 6			
	Threshold	0.25	N/A		0.25
	Brake Active	N/A	0 to 0.4		N/A
	Motor Disable	N/A	0.4 to 0.7..1.05		N/A
Direction Input V	CCW	< 1			
	CW	> 4			
Speed Output Signal	PPR	36			
Low Time	µsec	168			
Operating Temperature Range °C (°F)		0 – 70 (32 – 158)			
Thermal Limit Protection <sup>2</sup> °C		90 (194) flange temp. / 80 (176) restart			

Values valid for nominal voltage and Tamb = 22 °C

<sup>1</sup> Power supply provided with appropriate 1000 µF buffer capacitor between supply voltage and common to comply with EN 55014-1/2. (See additional EMC information on page 4.)

<sup>2</sup> Motor temperature measured at aluminum bearing support

# KinetiMax 68 EB – Performance

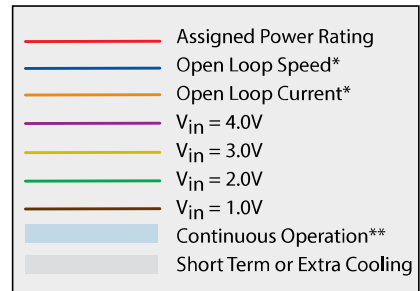
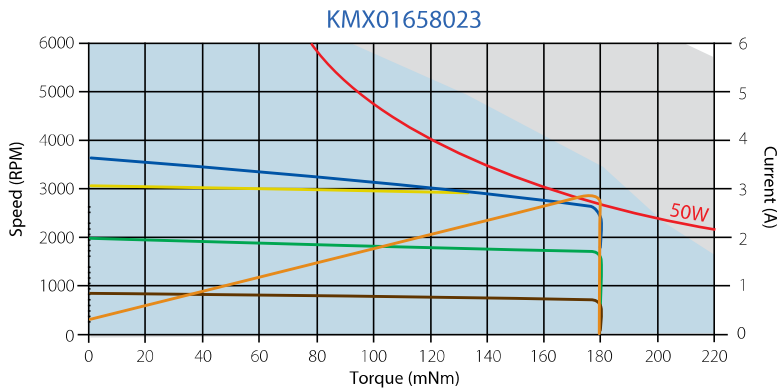
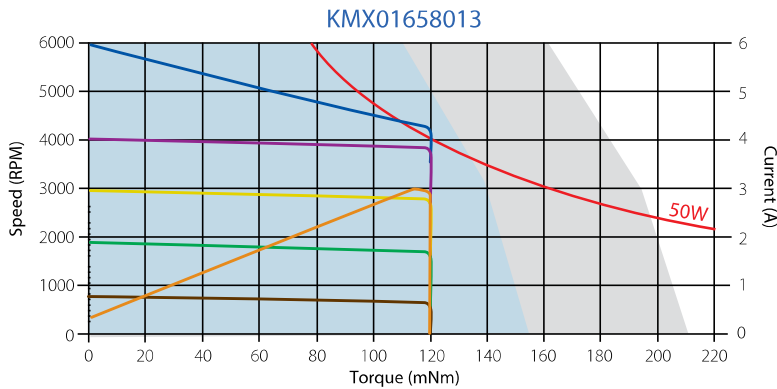
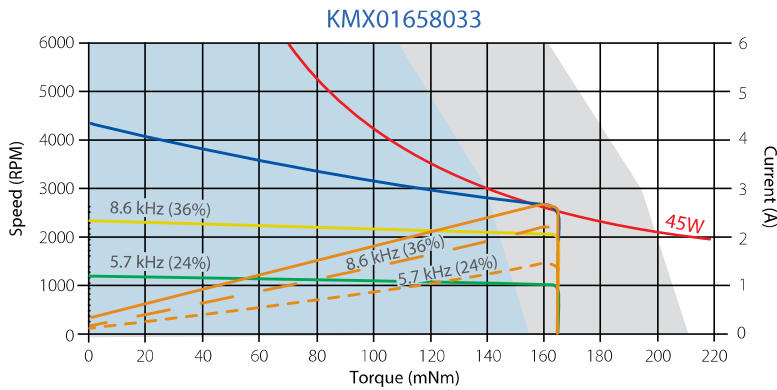
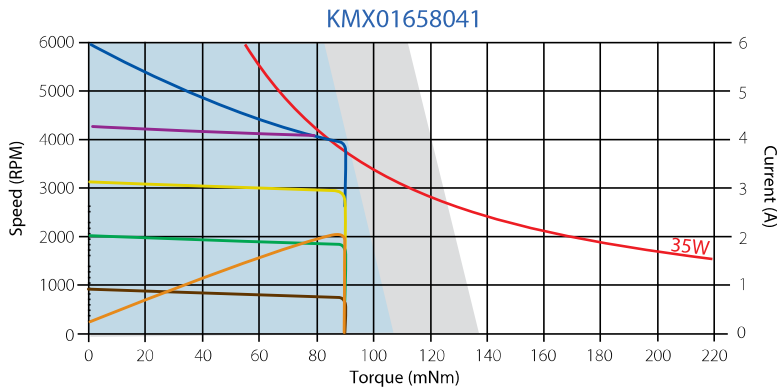

\* @ Rated Voltage

\*\*  $T_{amb} = 22^{\circ}C$

## KinetiMax 68 EB – I/O Schematics

### Speed Input

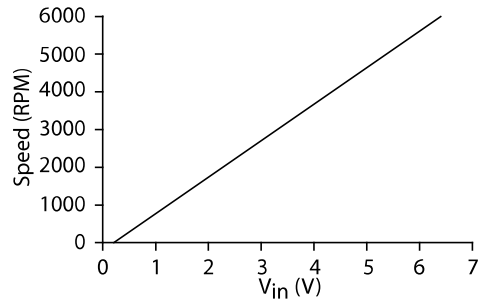
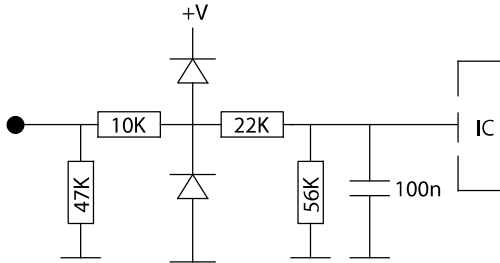

### Direction Input

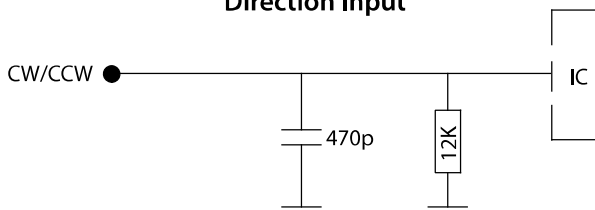

### Speed Output

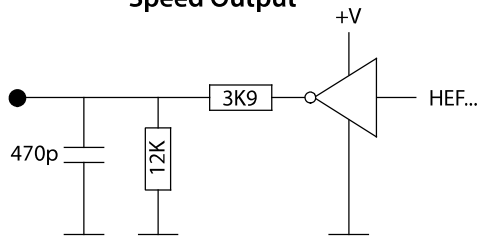

### Speed Output Signal

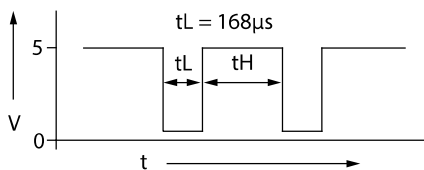

### EMC

To meet EMC directive EN 55014, the power supply must be provided with a capacitor 1000µf, 35V at the output:

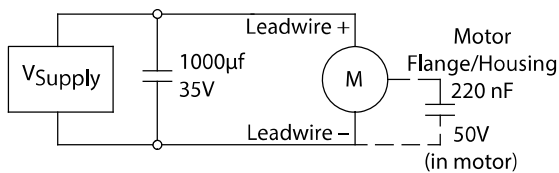

## KinetiMax 68 EB – Electrical Connections

Version	Description	Wire Color (AWG 24)
5-Wire	1 Supply voltage (+24V)	Red
	2 Ground	Black
	3 Speed control (V <sub>in</sub> ) 0 – 5V (1V/1000 RPM)	White
	4 Speed output (FG) 36 pulses/rev tachometer	Green
	5 Direction input (Fw/Rv) CCW/CW	Brown
	6 Shield/ground to motor housing	—

## KinetiMax 68 EB Dimensions — mm (in)

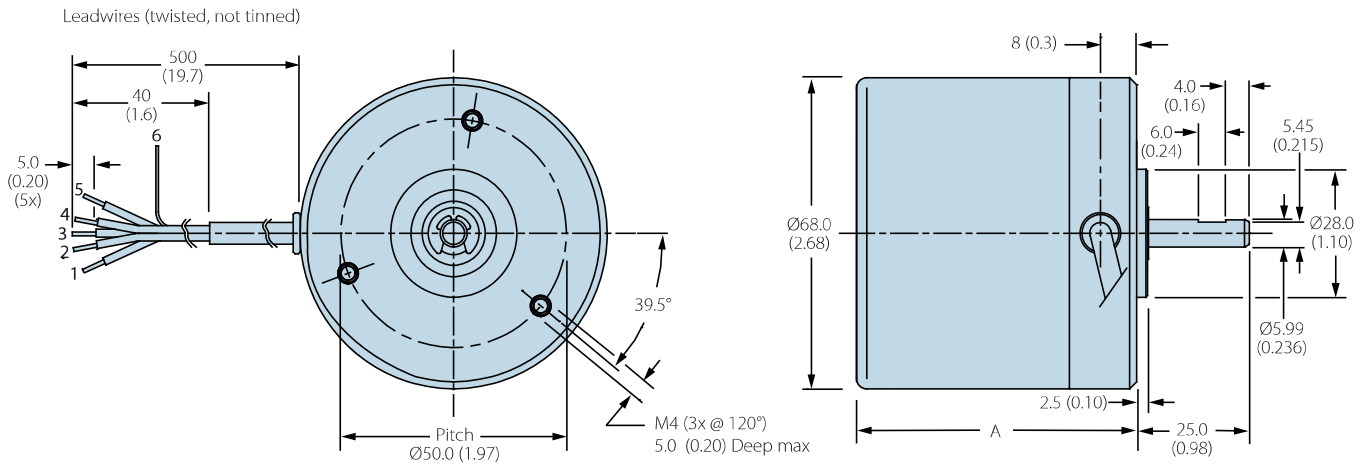

	Length A
KMX-01658041	49.1 (1.93)
KMX-01658033	
KMX-01658013	62.1 (2.44)
KMX-01658023	